

Article number: 20652026

Description: E+G Centring bore clamp GN 411.2-26.5-K

Measures

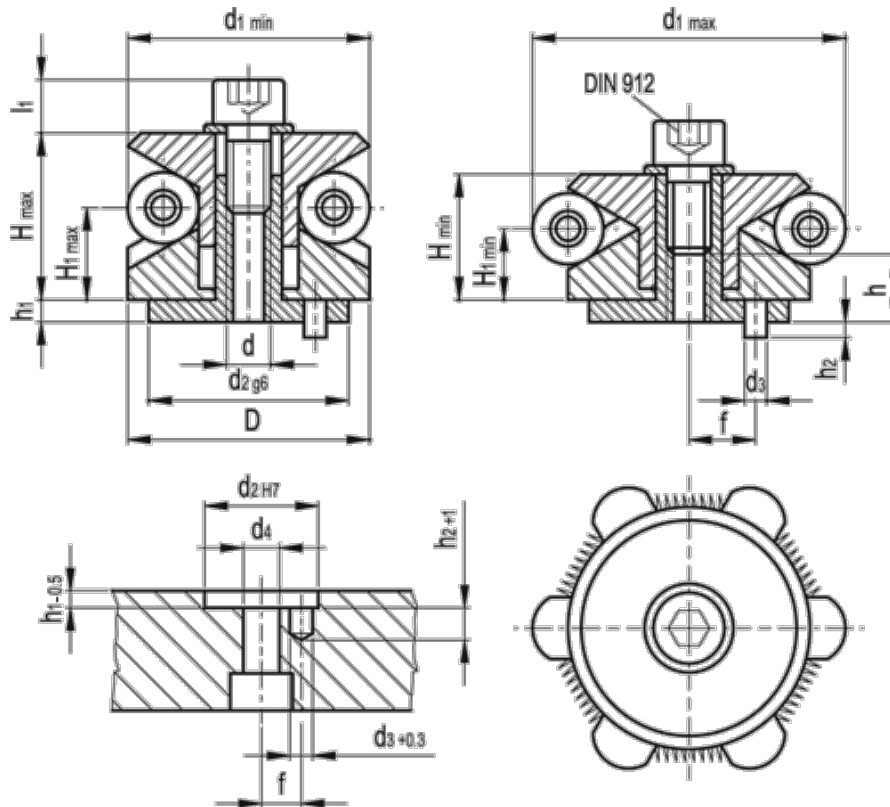

Clamping force (kN) = 5.00	d4 = 6.4	H min = 15.3
Clamping points = 3	f +/-0.1 = 7.0	l1 = 8.8
D = 26.5	h1 = 3.0	Weight (g) = 86
d = M6	H1 max = 12.6	
d1 max = 30.5	H1 min = 11.4	
d1 min = 26.5	h2 = 4.5	
d2 g6/H7 = 20	H max = 17.6	
d3 = 3.0	h min = 7	